



## AVN6558BT

### QUICK START GUIDE

Multimedia DVD Receiver with Built-in Navigation and Bluetooth featuring a 6.2" digital TFT LCD

This Quick Start Guide gives you the basics to start using your AVN6558BT. Please visit [www.axxeraaudio.com/support/manuals.php](http://www.axxeraaudio.com/support/manuals.php) to download a complete owner's manual or call customer service at 1-866-382-5476 (Monday-Friday, 9AM-5PM EST).



Customer Service Toll Free: 1-866-382-5476

#### Safety Notes:

The DVD video display of the in-dash unit will not operate while the vehicle is moving. This is a safety feature to prevent driver distraction. In-dash DVD video functions will only operate when vehicle is in Park and the parking brake is engaged. It is illegal in most states for the driver to view video while the vehicle is in motion.

## Installation

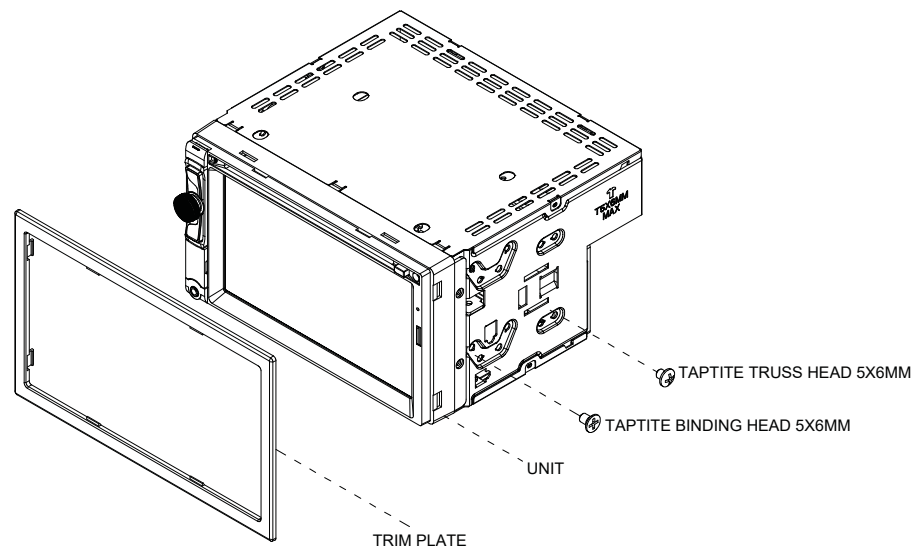

TYPICAL FRONT-LOAD DIN MOUNTING METHOD

#### Copyright and Trademark Notes

This product incorporates copyright protection technology that is protected by method claims of certain U.S. patents and other intellectual property rights owned by Macrovision Corporation and other rights owners. Use of this copyright protection technology must be authorized by Macrovision Corporation, and is intended for home and other limited viewing uses only unless otherwise authorized by Macrovision Corporation. Reverse engineering or disassembly is prohibited. DVD Logo is a trademark of DVD Format/Logo Licensing Corporation registered in the U.S., Japan and other countries. SD Logo is a trademark of SD-3C, LLC. iPod and iPhone are trademarks of Apple Inc., registered in the U.S. and other countries. Dual Electronics Corporation is not affiliated with Apple, Inc. Other trademarks and trade names are those of their respective owners.

## Wiring Diagram - Inputs/Outputs

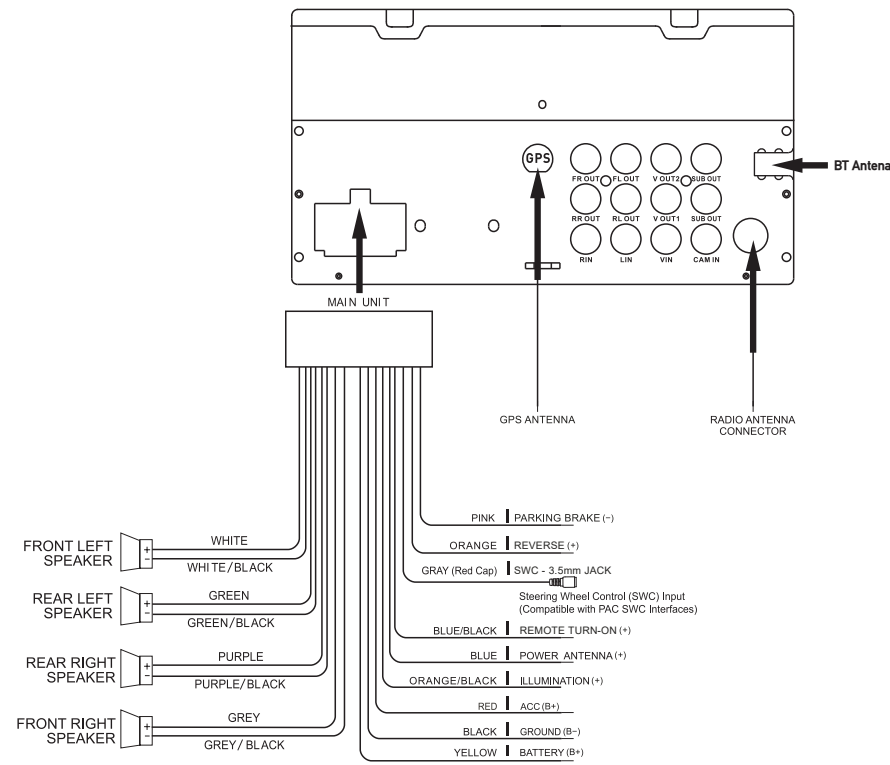

## Control Locations



- |                                |                      |               |
|--------------------------------|----------------------|---------------|
| 1. microSD Card (map only)     | 5. Navigation        | 9. USB Slot   |
| 2. Mic                         | 6. Tune/Track Up     | 10. AUX Input |
| 3. Eject - Press to eject disc | 7. Power/Volume/Mute |               |
| 4. Reset                       | 8. Tune/Track Down   |               |

## Remote Control

- |                        |                              |
|------------------------|------------------------------|
| 1. Power               | 15. Audio                    |
| 2. Mode                | 16. Goto/*                   |
| 3. Play/Pause          | 17. Loud/End call            |
| 4. Mute                | 18. Number keys              |
| 5. Title               | 19. Root                     |
| 6. Sub Title           | 20. OSD (On Screen Display)  |
| 7. Setup               | 21. Local/Random             |
| 8. Angle               | 22. Seek Down/Previous Track |
| 9. Eject               | 23. AS/PS/Repeat             |
| 10. Volume UP          | 24. Stereo                   |
| 11. Zoom               | 25. Stop                     |
| 12. Select/Talk        | 26. Enter                    |
| 13. Seek UP/Next Track | 27. Band                     |
| 14. Volume Down        |                              |

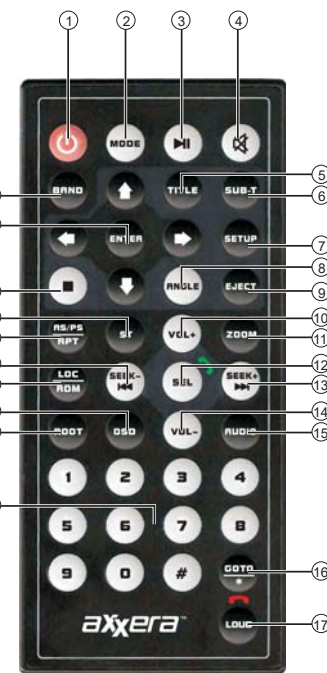

## Main Menu

In the Menu mode, press the desired icon to enter the corresponding mode: Radio, Disc, Navigation, Rear AV In, iPod/USB, BT Phone, BT Audio, Front AUX In.

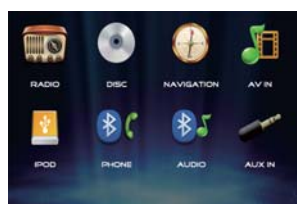

## General Operation

Press the function icons to select the setup menu.



## Tuner Operation

Select the Tuner icon from the Main Menu screen.

- |                           |              |
|---------------------------|--------------|
| 1. Current Mode Indicator | 6. Stereo    |
| 2. Information Display    | 7. Local/DX  |
| 3. Tune Up                | 8. Band      |
| 4. Preset                 | 9. Tune Down |
| 5. AS/PS                  |              |

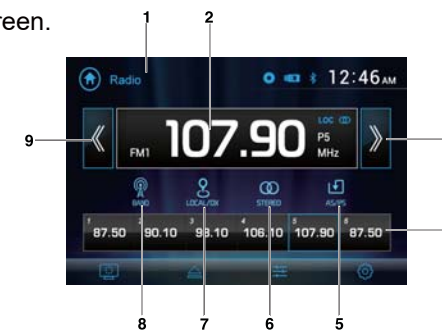

## DVD Operation

Insert a DVD in the disc slot for playback.

- |               |                   |
|---------------|-------------------|
| 1. Repeat     | 7. Setup          |
| 2. Track Down | 8. Monitor On/Off |
| 3. Play/Pause | 9. Audio Setting  |
| 4. Track Up   | 10. Subtitle      |
| 5. Random     | 11. Zoom          |
| 6. Audio      | 12. Screen Setup  |

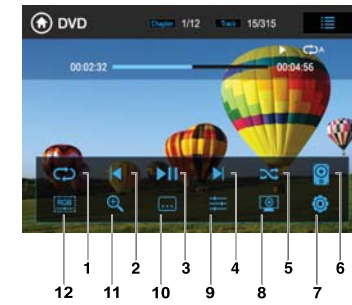

## CD / USB Operations

Insert a CD in the disc slot, and the unit will read the disc.

USB operation will work the same way when you insert the USB device into unit's USB port.

- |                  |                    |
|------------------|--------------------|
| 1. Previous Menu | 7. Audio           |
| 2. Repeat        | 8. Play/Pause      |
| 3. Random        | 9. Eject           |
| 4. Setting       | 10. Track Down     |
| 5. File List     | 11. Monitor On/Off |
| 6. Track Up      |                    |

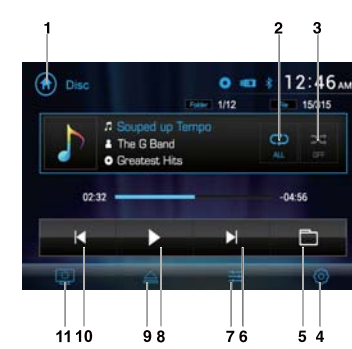

## Audio Operation

Press Sound Effect icon in the Settings menu to select EQ Presets, 7-Band Tone Control, Surround Sound, Fader and Balance controls.

- |                           |
|---------------------------|
| 1. EQ Settings            |
| 2. Surround Mode Settings |
| 3. Fader/Balance          |

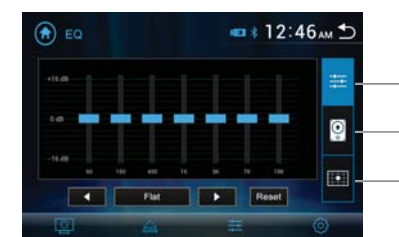

## iPod® Operation

Select iPod on the Main Menu. Connect an iPod device to play MP3 files.

- |                   |
|-------------------|
| 1. Previous Track |
| 2. Play/Pause     |
| 3. Next Track     |
| 4. Folder         |



## Navigation Operation

You can download the navigation manual by visiting the below link, [www.axxeraaudio.com/support/manuals.php](http://www.axxeraaudio.com/support/manuals.php)



## App Operation

The AxXera iPlug™ Smart App is the ultimate wireless remote control for your multimedia receiver. You can download the AxXera iPlug app from Apple Appstore or Google Playstore and install it on your smartphone or tablet.



## Bluetooth Operation

### Bluetooth Microphone

The microphone is built-in to the receiver.

### Pairing and Connecting

Before using Bluetooth functions, you must pair your mobile phone to the AVN6558BT unit. The device name is "AxXera AVN6558BT". The Bluetooth passcode "0000". To ensure the best reception for pairing and re-connection, please make sure the mobile phone battery is fully charged before you begin.

- Try to perform pairing within a few minutes of the mobile phone being turned on.
- Once the unit has been paired with the mobile phone, the unit's model number, "AVN6558BT", will be displayed on the mobile phone.
- To achieve the best performance, always keep the mobile phone within 10 feet (3 meters) of the unit.
- Always keep a clear path between the mobile phone and the unit. Never place a metal object or any other obstacle between the mobile phone and the unit.
- Some mobile phones may have a "Power Saving Mode" option. PLEASE DO NOT use the power saving mode with the AVN6558BT.
- Before accepting or making a call, make sure your mobile phone's "Bluetooth function" is turned on.
- To ensure the best conversation quality/performance, stay within 3 feet (1 meter) of the unit's microphone when talking.
- To manually disconnect the mobile phone from the unit, touch the "Hang-Up" icon on the Bluetooth user interface (next to the mobile phone name) and the Bluetooth device will be "disconnected", but still paired.

### Dialing a Number

Press to display keypad and dial a number.

### Making and Ending a Call

Press to connect a call, and press to end a call.

### Transferring Audio

Press to transfer audio between the head unit and mobile phone.

### Streaming Audio

Press to play or pause the music. Press to skip to the previous track. Press to advance to the next track.

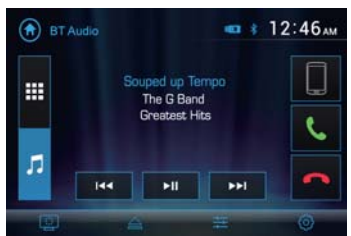

## One-Year Limited Warranty

This warranty gives you specific legal rights. You may also have other rights which vary from state to state. Dual Electronics Corp. warrants this product to the original purchaser to be free from defects in material and workmanship for a period of one year from the date of the original purchase. Dual Electronics Corp. agrees, at our option, during the warranty period, to repair any defect in material or workmanship or to furnish an equal new, renewed or comparable product (whichever is deemed necessary) in exchange without charges, subject to verification of the defect or malfunction and proof of the date of purchase. Subsequent replacement products are warranted for the balance of the original warranty period. Who is covered? This warranty is extended to the original retail purchaser for products purchased from an authorized Dual dealer and used in the U.S.A. What is covered? This warranty covers all defects in material and workmanship in this product. The following are not covered: software, installation/removal costs, damage resulting from accident, misuse, abuse, neglect, product modification, improper installation, incorrect line voltage, unauthorized repair or failure to follow instructions supplied with the product, or damage occurring during return shipment of the product. Specific license conditions and copyright notices for the software can be found via [www.dualav.com](http://www.dualav.com).

#### What to do?

1. Before you call for service, check the troubleshooting guide in your owner's manual. A slight adjustment of any custom controls may save you a service call.
  2. If you require service during the warranty period, you must carefully pack the product (preferably in the original package) and ship it by prepaid transportation with a copy of the original receipt from the retailer to an authorized service center.
  3. Please describe your problem in writing and include your name, a return UPS shipping address (P.O. Box not acceptable), and a daytime phone number with your shipment.
  4. For more information and for the location of the nearest authorized service center please contact us by one of the following methods:
    - Call us toll-free at 1-866-382-5476 (Monday-Friday, 9:00 a.m. to 5:00 p.m. EST)
    - E-mail us at [cs@dualav.com](mailto:cs@dualav.com)
- Exclusion of Certain Damages: This warranty is exclusive and in lieu of any and all other warranties, expressed or implied, including without limitation the implied warranties of merchantability and fitness for a particular purpose and any obligation, liability, right, claim or remedy in contract or tort, whether or not arising from the company's negligence, actual or imputed. No person or representative is authorized to assume for the company any other liability in connection with the sale of this product. In no event shall the company be liable for indirect, incidental or consequential damages.

## FCC Compliance

This device complies with Part 15 of the FCC Rules. Operation is subject to the following two conditions: (1) this device may not cause harmful interference, and (2) this device must accept any interference received, including interference that may cause undesired operation. **Warning:** Changes or modifications to this unit not expressly approved by the party responsible for compliance could void the user's authority to operate the equipment. **Note:** This equipment has been tested and found to comply with the limits for a Class B digital device, pursuant to Part 15 of the FCC Rules. These limits are designed to provide reasonable protection against harmful interference in a residential installation. This equipment generates, uses and can radiate radio frequency energy and, if not installed and used in accordance with the instructions, may cause harmful interference to radio communications. However, there is no guarantee that interference will not occur in a particular installation. If this equipment does cause harmful interference to radio or television reception, which can be determined by turning the equipment off and on, the user is encouraged to try to correct the interference by one or more of the following measures:

- Reorient or relocate the receiving antenna.
- Increase the separation between the equipment and receiver.
- Connect the equipment into an outlet on a circuit different from that to which the receiver is connected.
- Consult the dealer or an experienced radio/TV technician for help.