



AV1014BH

QUICK START GUIDE

DVD Multimedia Receiver with 10.1" LCD, Bluetooth® and DualMirror™

This Quick Start Guide gives you the basics to start using your AV1014BH. Please visit www.axxeraaudio.com/downloads/manuals/av1014bh.pdf download a complete owner's manual or call customer service at 1-866-382-5476 (Monday-Friday, 9AM-5PM EST).



Customer Service Toll Free: 1-866-382-5476

Safety Notes:
The DVD video display of the in-dash unit will not operate while the vehicle is moving. This is a safety feature to prevent driver distraction. In-dash DVD video functions will only operate when vehicle is in Park and the parking brake is engaged. It is illegal in most states for the driver to view video while the vehicle is in motion.

Installation

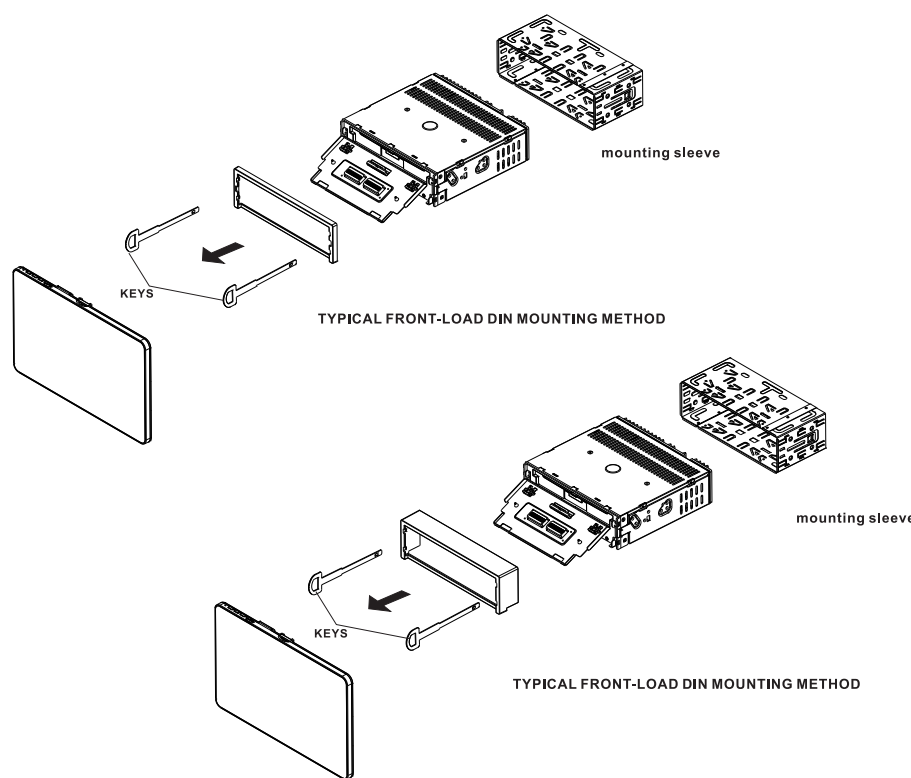

Copyright and Trademark Notes
This product incorporates copyright protection technology that is protected by method claims of certain U.S. patents and other intellectual property rights owned by Macrovision Corporation and other rights owners. Use of this copyright protection technology must be authorized by Macrovision Corporation, and is intended for home and other limited viewing uses only unless otherwise authorized by Macrovision Corporation. Reverse engineering or disassembly is prohibited. Manufactured under license from Dolby Laboratories. Dolby and the double-D symbol are trademarks of Dolby Laboratories. DVD Logo is a trademark of DVD Format/Logo Licensing Corporation registered in the U.S., Japan and other countries. SD Logo is a trademark of SD-3C, LLC. iPod and iPhone are trademarks of Apple Inc., registered in the U.S. and other countries. Dual Electronics Corporation is not affiliated with Apple, Inc. Other trademarks and trade names are those of their respective owners.

Wiring Diagram - Inputs/Outputs

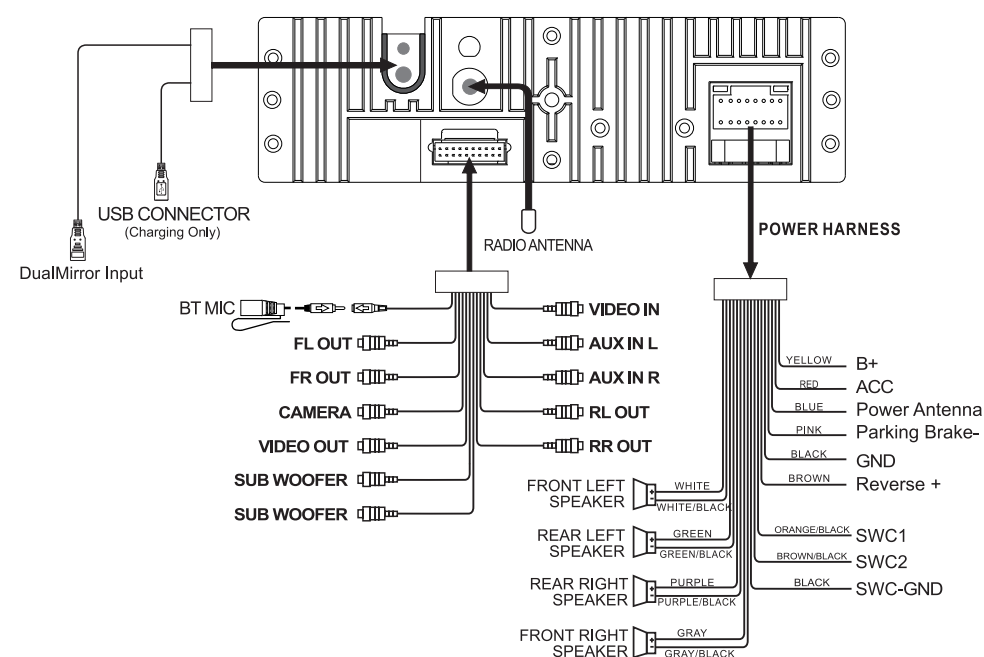

Control Locations



1. Power
2. Volume Down
3. Volume Up
4. Eject
5. SD Card

Remote Control

- | | |
|-------------------|-----------------------------|
| 1. Power | 12. Setup |
| 2. Eject | 13. Search |
| 3. Mode | 14. Repeat |
| 4. Open | 15. Angle/# |
| 5. Up | 16. Audio/* |
| 6. Menu | 17. OSD (On Screen Display) |
| 7. Volume Up | 18. Zoom/Talk |
| 8. Mute | 19. ESC |
| 9. Select | 20. Band |
| 10. Enter | 21. Volume Down |
| 11. Root/Call END | 22. Play/Pause |
| | 23. Down |

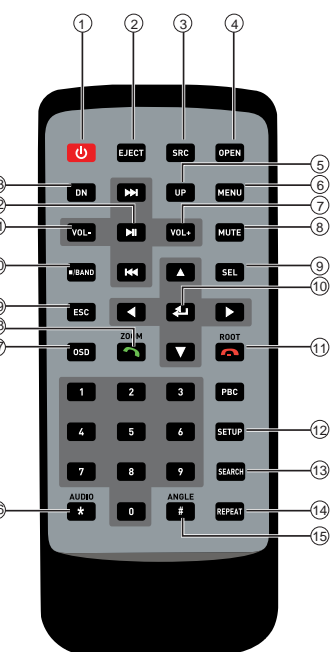

Main Menu

In the Menu mode, press the desired icon to enter the corresponding mode: Tuner, Disc, USB, SD Card, AV Front, AV Rear, Bluetooth, DualMirror, Camera, Setup.

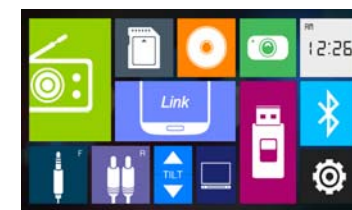

Tuner Operation

Select the Tuner icon from the Main Menu screen or press MODE until Tuner is selected.

1. Current Mode Indicator
2. Information Display
3. Tune Up
4. Tune Down
5. Mute On/OFF
6. Setup
7. EQ
8. Preset Station Display
9. LOC
10. LOUD
11. AS/PS



DVD Operations

- | | |
|------------------|------------------|
| 1. Dimmer | 13. Play/Pause |
| 2. Setup | 14. Volume Down |
| 3. Info | 15. Volume Up |
| 4. EQ | 16. Mode display |
| 5. Direct Access | 17. Repeat Play |
| 6. Page Up/Down | 18. A-B |
| 7. Zoom | 19. Audio |
| 8. Fast Forward | 20. Sub-T |
| 9. Rewind | 21. Root |
| 10. Tune Up | 22. Title |
| 11. Tune Down | 23. Angle |
| 12. Stop | |

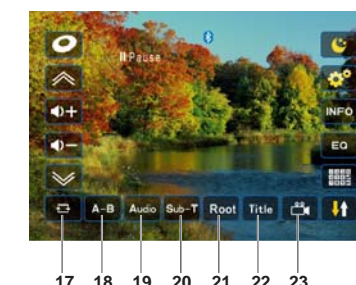

CD/USB/SD Operation

Insert a CD in the disc slot, and the unit will read the disc. (Insert a USB/SD Card)

1. Page Down
2. Page Up
3. Direct Access
4. Previous Folder
5. Intro
6. Random Play
7. Repeat Play
8. Next Song(short press) / Fast Forward(long press)
9. Previous Song(short press) / Rewind(long press)
10. Stop
11. Play/Pause
12. Audio Settings
13. Mute



EQ Operation

1. Balance/Fader Control
2. Treble
3. Bass
4. Loudness
5. EQ (User/Pop/Jazz/Classic/Rock)

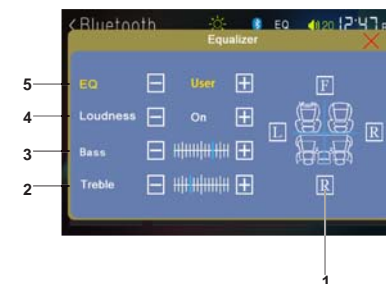

General Operations

Setup Menu

From the Main Menu screen, press Setup to enter the Setup Menu. The first 7 setup options will be displayed on the screen.



Bluetooth Operation

Bluetooth Microphone

Bluetooth feature of the AV1014BH includes an external microphone that can be mounted in a location close the driver for better clarity, usually mounted on the drivers A-pillar or on the center roof between the sun visors.

Pairing and Connecting

Before you can use a Bluetooth device, it must be paired and connected. The unit broadcasts the pairing signal constantly when no devices are currently connected. Complete the pairing sequence from your Bluetooth device. The device name is "Dual BT". Once pairing is complete, most Bluetooth will connect automatically if the device is in range when the unit is powered-on.

Dialing a Number

Press # to display keypad and dial a number.

Making and Ending a Call

Press to connect a call, and press to end a call.

Accessing Recent Call List

Press to access the recent call list and view/select numbers from recent Received, Dialed or Missed calls.

Transferring Audio

Press to transfer audio between the head unit and mobile phone.

Streaming Audio

Press to enter the music control menu. Press to play or pause the music. Press to skip to the previous track. Press to advance to the next track.

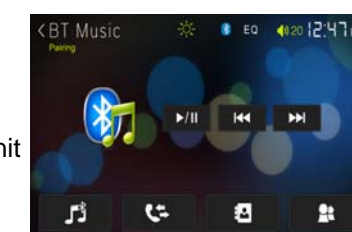
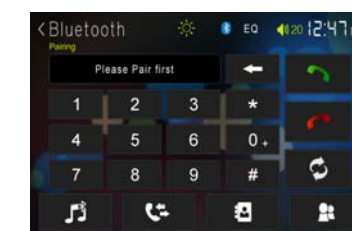

DualMirror™ Operation

See insert for DualMirror operation.

One-Year Limited Warranty

This warranty gives you specific legal rights. You may also have other rights which vary from state to state.

Dual Electronics Corp. warrants this product to the original purchaser to be free from defects in material and workmanship for a period of one year from the date of the original purchase.

Dual Electronics Corp. agrees, at our option, during the warranty period, to repair any defect in material or workmanship or to furnish an equal new, renewed or comparable product (whichever is deemed necessary) in exchange without charges, subject to verification of the defect or malfunction and proof of the date of purchase. Subsequent replacement products are warranted for the balance of the original warranty period.

Who is covered? This warranty is extended to the original retail purchaser for products purchased from an authorized Dual dealer and used in the U.S.A.

What is covered? This warranty covers all defects in material and workmanship in this product. The following are not covered: software, installation/removal costs, damage resulting from accident, misuse, abuse, neglect, product modification, improper installation, incorrect line voltage, unauthorized repair or failure to follow instructions supplied with the product, or damage occurring during return shipment of the product. Specific license conditions and copyright notices for the software can be found via www.dualav.com.

What to do?

1. Before you call for service, check the troubleshooting guide in your owner's manual. A slight adjustment of any custom controls may save you a service call.
2. If you require service during the warranty period, you must carefully pack the product (preferably in the original package) and ship it by prepaid transportation with a copy of the original receipt from the retailer to an authorized service center.
3. Please describe your problem in writing and include your name, a return UPS shipping address (P.O. Box not acceptable), and a daytime phone number with your shipment.
4. For more information and for the location of the nearest authorized service center please contact us by one of the following methods:
 - Call us toll-free at 1-866-382-5476 (Monday-Friday, 9:00 a.m. to 5:00 p.m. EST)
 - E-mail us at cs@dualav.com

Exclusion of Certain Damages: This warranty is exclusive and in lieu of any and all other warranties, expressed or implied, including without limitation the implied warranties of merchantability and fitness for a particular purpose and any obligation, liability, right, claim or remedy in contract or tort, whether or not arising from the company's negligence, actual or imputed. No person or representative is authorized to assume for the company any other liability in connection with the sale of this product. In no event shall the company be liable for indirect, incidental or consequential damages.